

# 326 SERIES

## Wall profile

For use in  
hospitals • airports • shopping centres • rail stations  
• offices • schools



### Features:

- Attractive finish
- Solid aluminium construction with Nitriflex rubber insert
- Insert colours: black or grey. Alternative RAL coloured inserts are available - minimum order quantity applies.
- Smooth insert option available for laboratories and hospital wards (note: smooth insert reduces movement, contact us for further details).
- Standard 4 metre lengths
- Corner/angle options
- Ideal for areas where ground settlement is a problem

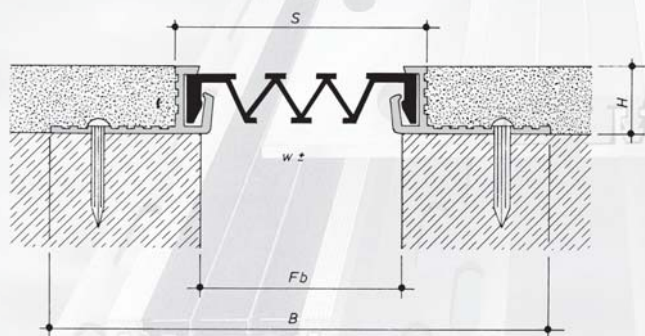

Profile reference	326-030	326-050	326-080	326-120	326-200	326-280	326-350
Fb - Joint widths upto (mm)	30	50	80	120	200	280	350
H - Heights (mm)	17	17	17	17	17	17	17
B - Overall width (mm)	100	130	160	180	280	360	430
S - Visible width (mm)	34	60	95	115	210	295	365
Movement Total (+/- mm)	10 (+8/-2)	30 (+20/-10)	45 (+30/-15)	65 (+45/-20)	90 (+50/-40)	125 (+80/-45)	150 (+100/-50)

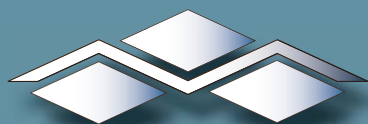

**Movement Joints (UK) Ltd,**  
Unit 3, 57 Thorby Avenue, March, Cambridgeshire PE15 0AZ United Kingdom  
Tel: 01354 60 79 60 Fax: 01354 60 78 33  
Web: [www.mjuk.co.uk](http://www.mjuk.co.uk) e-mail: [info@mjuk.co.uk](mailto:info@mjuk.co.uk)

**IMPORTANT:** Whilst all reasonable care is taken in compiling technical data on the company's products, all recommendations or suggestions regarding the use of such products are made without guarantee since the conditions of use are beyond the company. It is the customers responsibility to satisfy himself that each product is fit for the purpose for which he intends to use it and that the actual conditions of use are suitable.